

# INSTALLATION OF THE STAR MACHINE TWIN MOTOR EVP AND BATTERY

- **PAGE 1:** VACUUM PUMP DESCRIPTION AND OPERATION
- **PAGE 2 :** OVERALL DIMENSIONS OF VACUUM PUMP
- **PAGES 3 THRU 8:** INSTALLATION
- **PAGES 9:** REGULAR MAINTENANCE , BATTERY PERFORMANCE TIPS
- **PAGES 10 THRU 13:** DYNAMIC SEAL REPLACEMENT
- **PAGE 14:** INTAKE AND EXHAUST TUBE REPOSITIONING
- **PAGE 15:** TWIN MOTOR WIRING
- **PAGE 16:** TWIN MOTOR DRIVE INSTALL



STAR MACHINE  
7810 OAK AVENUE  
PARKVILLE, MARYLAND 21234

PHONE: 667.210.3874  
FAX: 410.661.2467  
EMAIL: STARVACUUMPUMPS@GMAIL.COM

The Star Machine Electric Vacuum Pump (EVP) is representative of our continued efforts to provide racers with the latest vacuum pump technology. The EVP is a DC electric, reciprocating piston vacuum pump. It incorporates two dynamic seal pistons, coupled to a common yoke that is eccentrically driven in a common bore. The EVP offers the distinct advantage of ALL the HP gains, thru increased crank case vacuum, with ZERO HP lost to driving a mechanical vacuum pump.

Originally designed for Pro Stock Motorcycle to comply with the one pump rule it is also currently used in Pro Stock Car as a vacuum assist pump. In PSB applications it is equal to 5 times the capacity of the most commonly used pump to produce crank case vacuum. In PSB it is producing vacuum levels of 25" Hg.(wire to wire). In PS Car applications it has shown a 15 - 20% increase over existing crank case vacuum readings.

At Star Machine we realize that you don't get something for nothing. The electric motor driven EVP adds the requirement of between round battery maintenance (recharging). This will be considered, by some racers as a burden (one more between round headache). Other racers, looking for that last .01 second advantage, will view the additional maintenance as part of the game.

The EVP Kit is sold (complete) with two 24 VDC rechargeable batteries, and charger, quick change (battery) holder, wiring harness and vacuum hose. The EVP operates (completely) separate from your existing (12/16 VDC) electrical system. To complete the EVP installation one 12V-75A normally open switch is required to operate the pump. We recommend switching the positive side. If you would like to control the EVP with a relay we recommend the Bosch 24VDC/50A, PN 0.332.002.250. DO NOT GROUND ANY OF THE EVP WIRES TO THE VEHICLE.

**The use of other battery systems is not recommended and could lead to motor, wiring and mechanical failures of the pump. While lithium-poly batteries may offer a weight advantage, they pose a true risk of fire. Please contact Star Machine to discuss the application of alternate power sources.**

Activating the pump is presently (and recommended) done when the vehicle is pre-staged. In most cases at the same time the data recorder is switched on. This will guarantee the pump motor will receive the maximum available battery power.

The vacuum line connection to the engine is critical to the operation of the EVP. Drawing oil into the EVP may result in damage to the reeds. Care must be taken to baffle and/or separate the engine oil from the air drawn by the pump. More important to the performance of the pump is the sealing of the engine, the better the seal the higher the potential vacuum. We also recommend that a check valve be installed in the vacuum line, at the pump inlet.

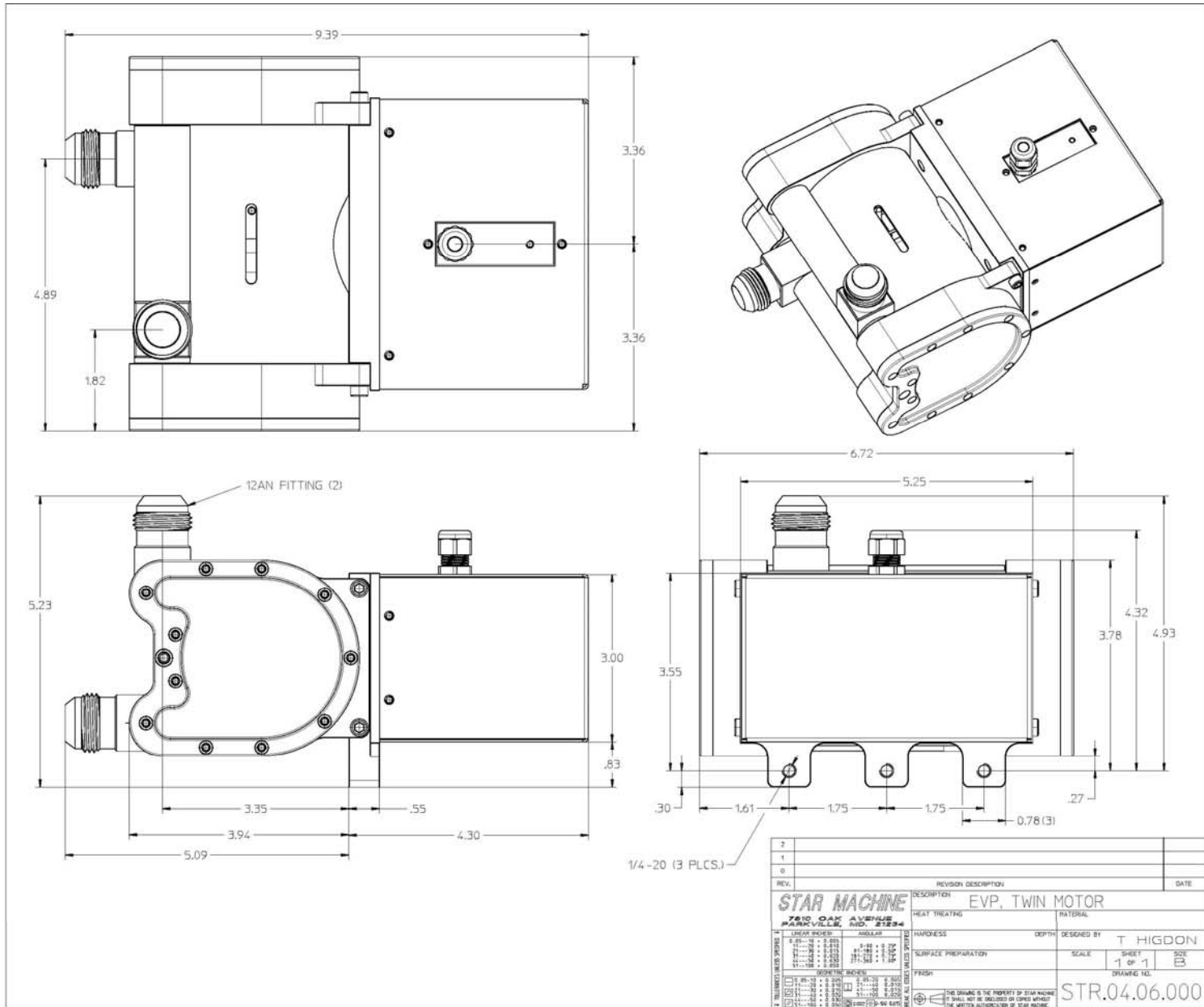

# MOUNTING THE VACUUM PUMP AND BATTERY HOLDER

THE PUMP CAN BE MOUNTED IN ANY POSITION HOWEVER WE RECOMMEND THAT THE CHOSEN POSITION HAS THE EXHAUST (RED) TUBE LOWER THAN THE INTAKE (BLUE) TUBE OR THE RED TUBE IS BELOW THE PUMP BODY

- PHOTO 2 SHOWS THE THREE MOUNTING HOLES OF THE PUMP
- PHOTO 1 SHOWS THE SHOWS THE TWO MOUNTING HOLES FOR THE BATTERY HOLDER
- PG. 4; PHOTOS 3 & 4 SHOW UNAPPROVED MOUNTING POSITIONS FOR THE BATTERY HOLDER  
(IN THESE CASES IF THE LATCH IS NOT ENGAGED THE BATTERY MAY SLIDE OUT OF THE HOLDER UNDER DECELERATION)
- PG. 4; PHOTOS 5 & 6 SHOW APPROVED MOUNTING POSITIONS (PHOTO 6 SHOWS THE BEST POSITION)

(APPROVED POSITIONS ARE WHERE THE BATTERY INSTALL/REMOVAL DIRECTION IS PERPENDICULAR TO THE DIRECTION OF VEHICLE TRAVEL)

**\*\* WITH ONE EXCEPTION, WHERE THE BATTERY IS PULLED DOWNWARD FOR REMOVAL \*\***

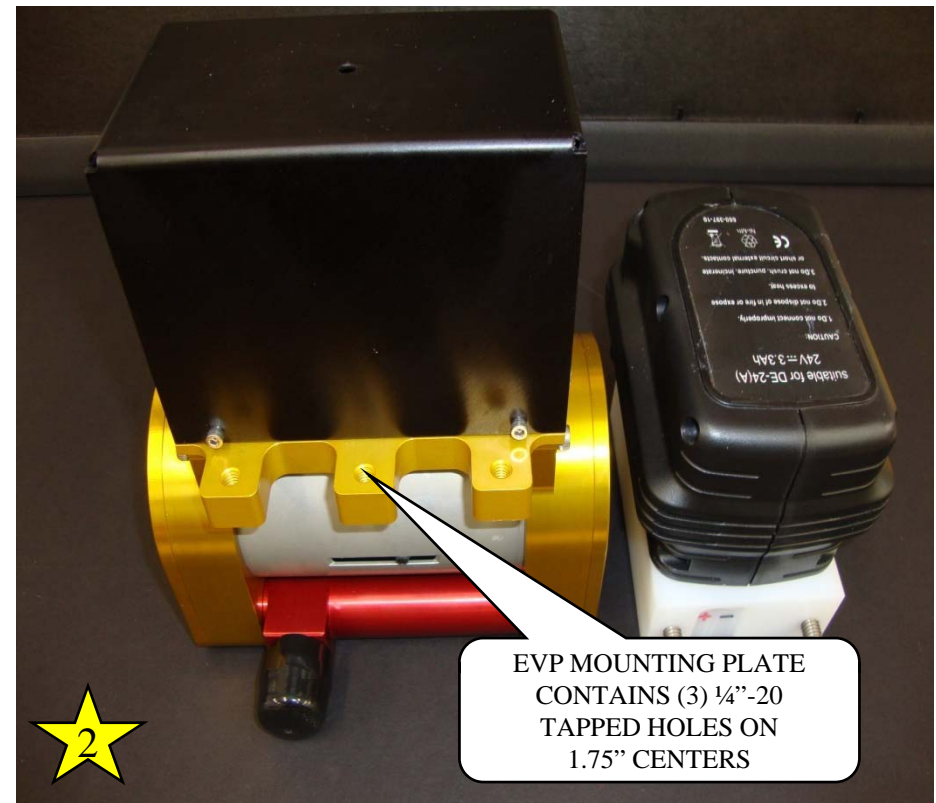
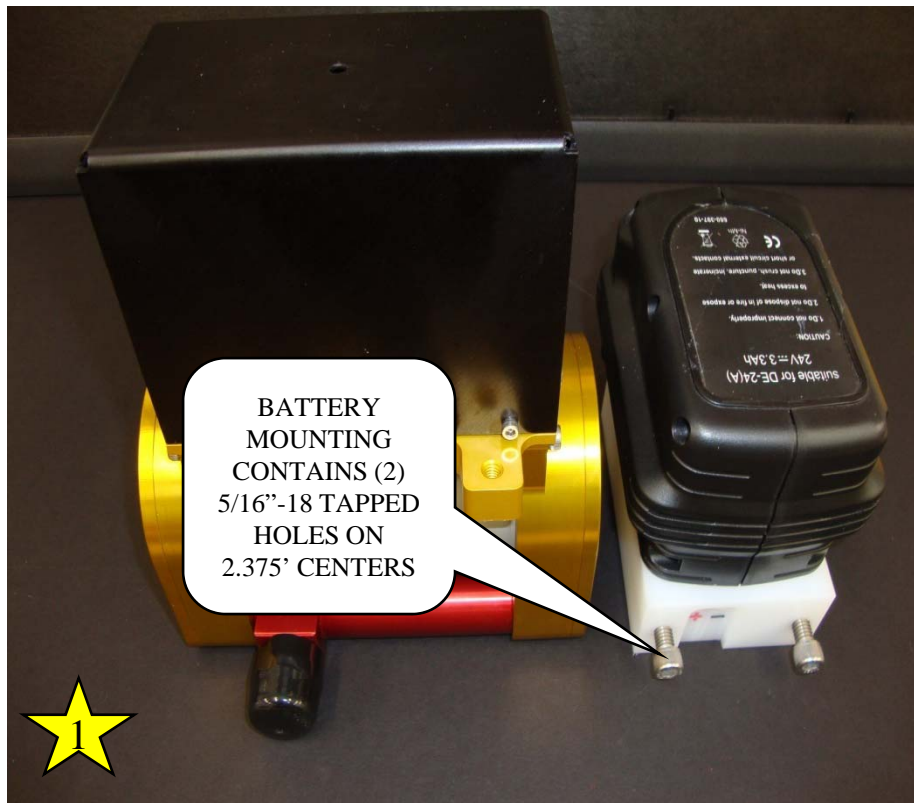

↑ FRONT OF VEHICLE ↑

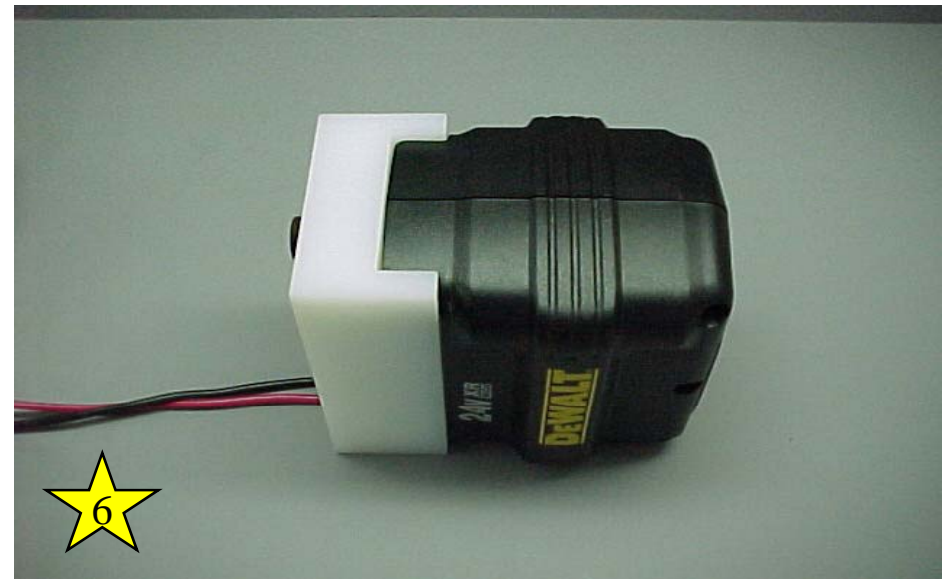
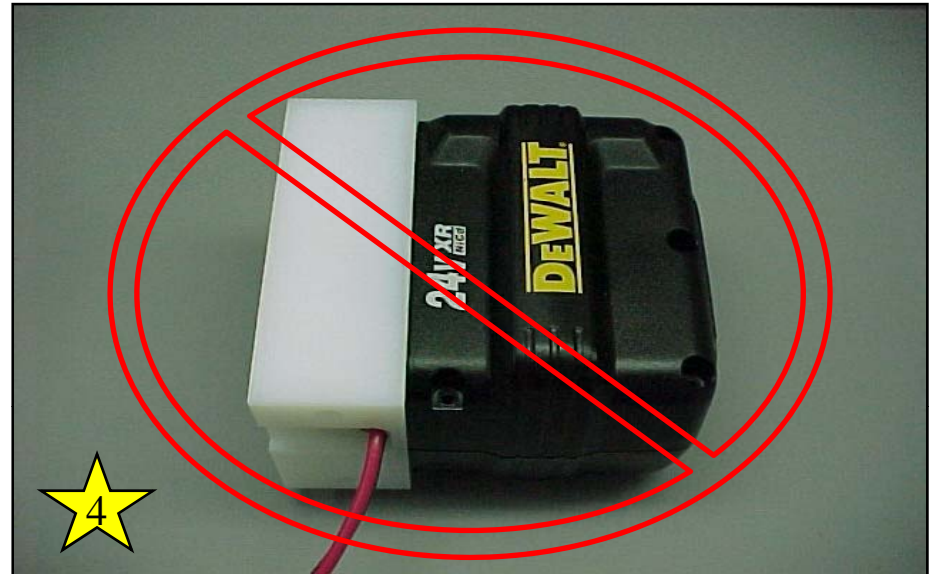



# WIRING THE VACUUM PUMP

- PHOTO 7: EVP CONNECTORS; THE FEMALE END IS CONNECTED TO THE BATTERY BLOCK, USE A NORMALLY OPEN SWITCH RATED FOR 12 VDC @ 75 AMPS (MINIMUM CONTINUOUS) AND 80A INRUSH TO ACTIVATE THE PUMP. WE RECOMMEND SWITCHING THE POSITIVE LEAD.
- IF YOU WOULD LIKE TO CONTROL THE EVP WITH A RELAY WE RECOMMEND THE BOSCH 24VDC/50A PN 0.332.002.250.
- DO NOT GROUND ANY OF THE EVP WIRES TO THE VEHICLE.
- PHOTO 8: SHOWS THE CONNECTION TO THE BATTERY HOLDER BLOCK

**NOTE: THE TWIN MOTOR EVP'S ARE POLARITY SENSITIVE !**

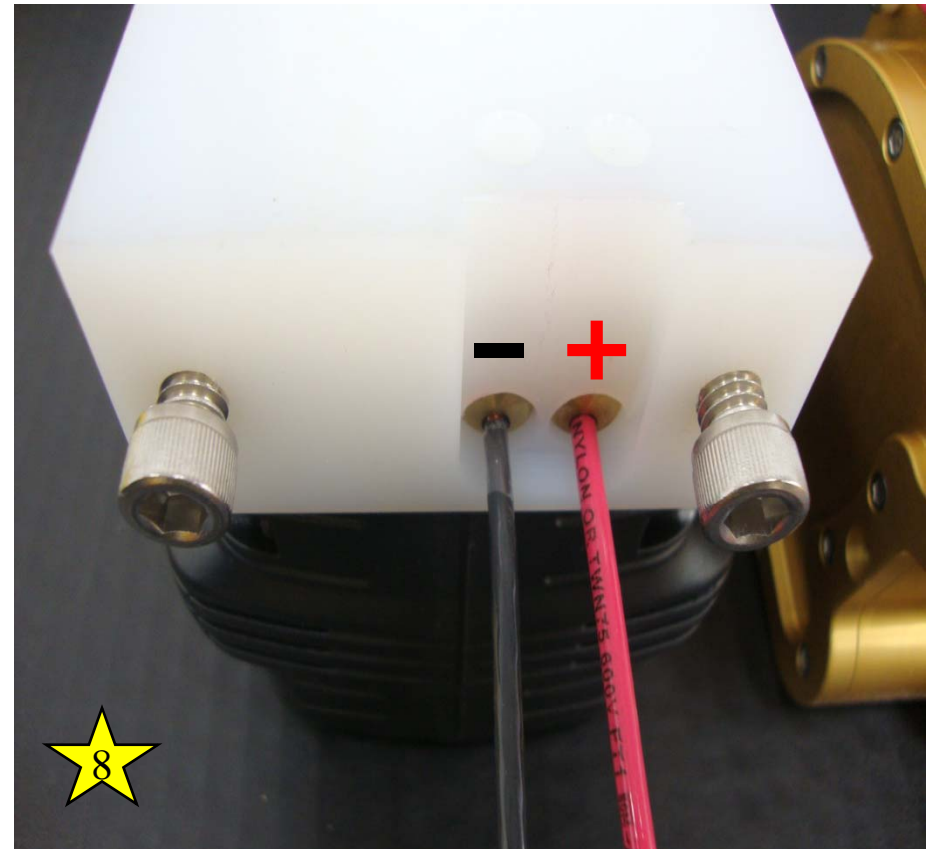
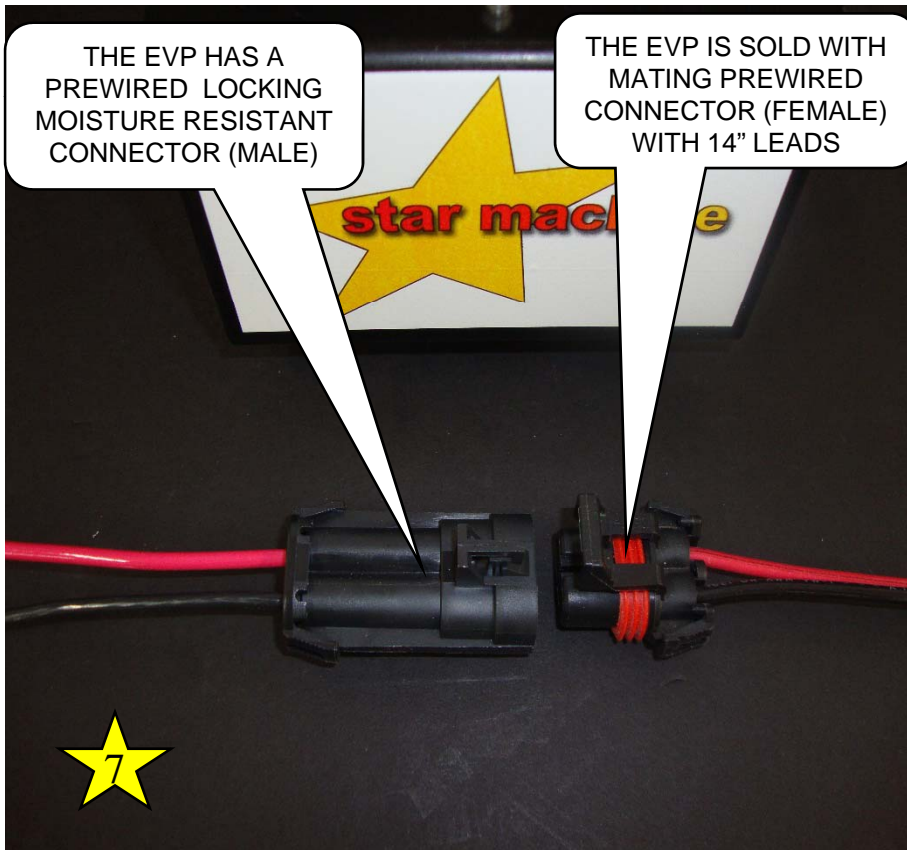

# WIRING THE VACUUM PUMP

- PHOTOS 9 AND 10 DETAIL THE BATTERY CONNECTION, USE 12 AWG (19 STRAND THHN) WIRE

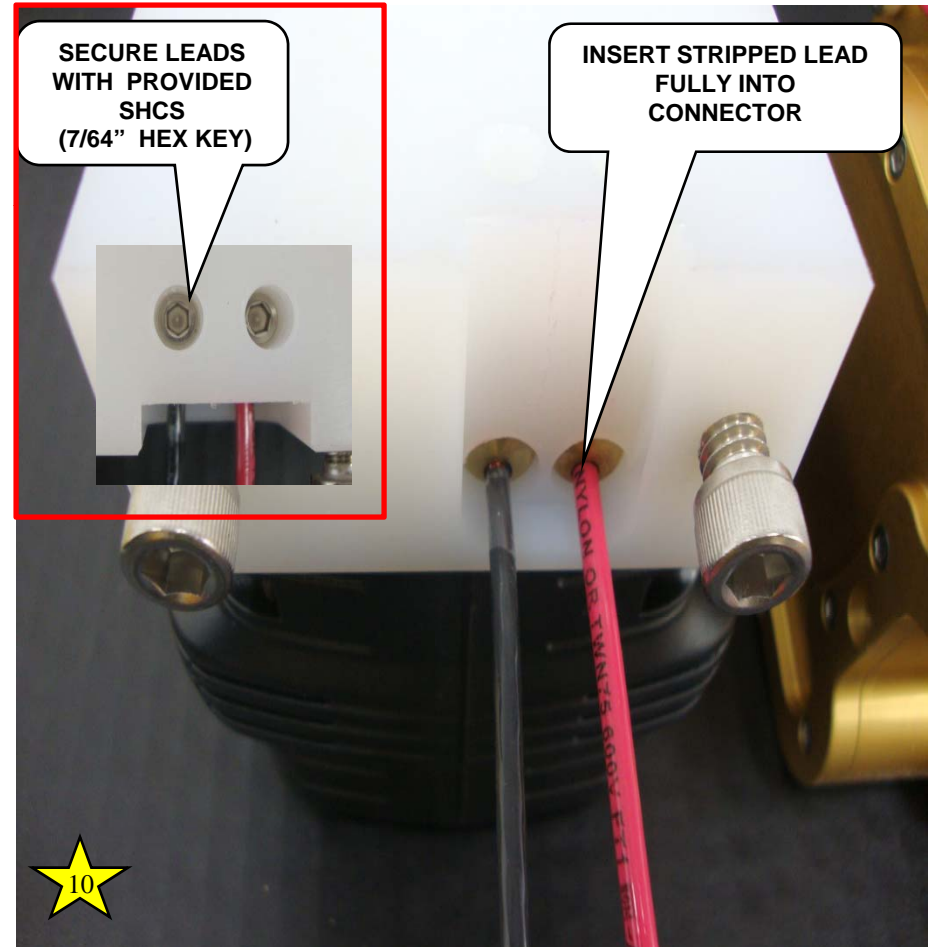
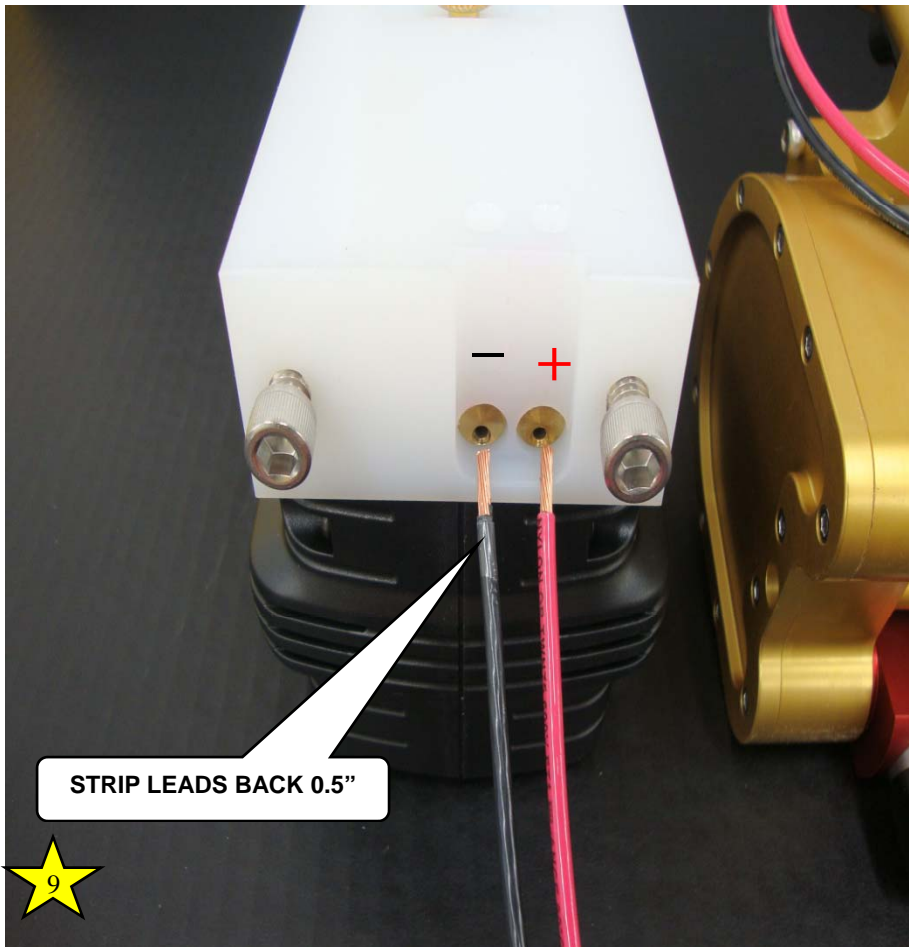

# PLUMBING THE VACUUM PUMP

- THE PUMP IS SUPPLIED WITH -12 AN MALE FITTINGS ( $\frac{3}{8}$ " SLIP ON FITTINGS ARE SPECIAL ORDER)
- CONNECT THE HOSE FROM THE ENGINE TO THE BLUE TUBE
- CONNECT A HOSE FROM THE RED TUBE TO A CATCH CAN. THE CATCH VENT MUST BE CAPABLE OF FLOWING A MINIMUM OF 16 SCFM
- THE POSITION OF THE INTAKE AND EXHAUST TUBES CAN BE CHANGED. AS SHOWN IN THE PHOTO; BLUE TUBE IS ON THE RIGHT AND THE RED ON THE LEFT. HOWEVER THEY CAN BE POSITIONED BOTH TO THE RIGHT OR BOTH TO THE LEFT OR BLUE-LEFT AND RED- RIGHT (SEE PAGE 14 FOR REPOSITIONING THE INT/EXH TUBES)
- ONCE INSTALLED THEY CAN BE ROTATED ABOUT THEIR LENGTH (AXIS) AS WELL
- WHEN MOUNTED THE RED (EXHAUST) TUBE MUST BE BELOW THE BLUE (INTAKE) OR BOTH TUBES BELOW THE BLACK MOTOR COVER AS SHOWN

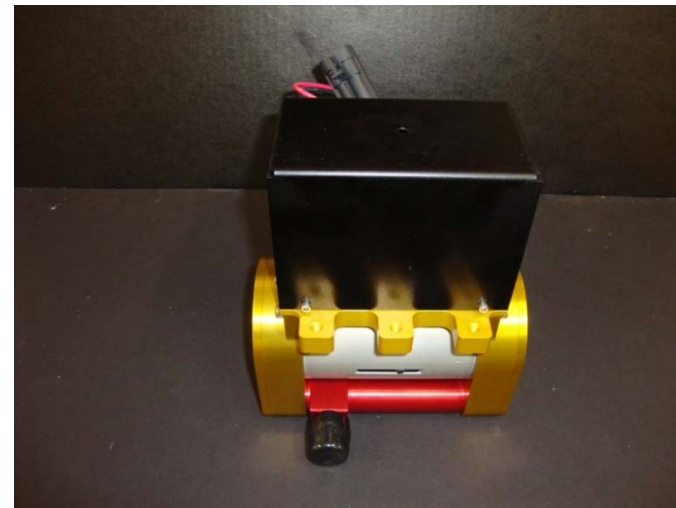



## LOADING BATTERY INTO HOLDER

- RETRACT BATTERY RETAINING PIN (PHOTO 1)
- SLIDE BATTERY OUT OF HOLDER
- SLIDE FULLY CHARGED BATTERY INTO HOLDER  
DO NOT FORCE BATTERY! CHECK THE GAP IN THE CONTACT(S). SEE: REGULAR MAINTENANCE (PG. 9)
- PULL BACK ON BATTERY TO INSURE THAT RETAINING PIN HAS ENGAGED

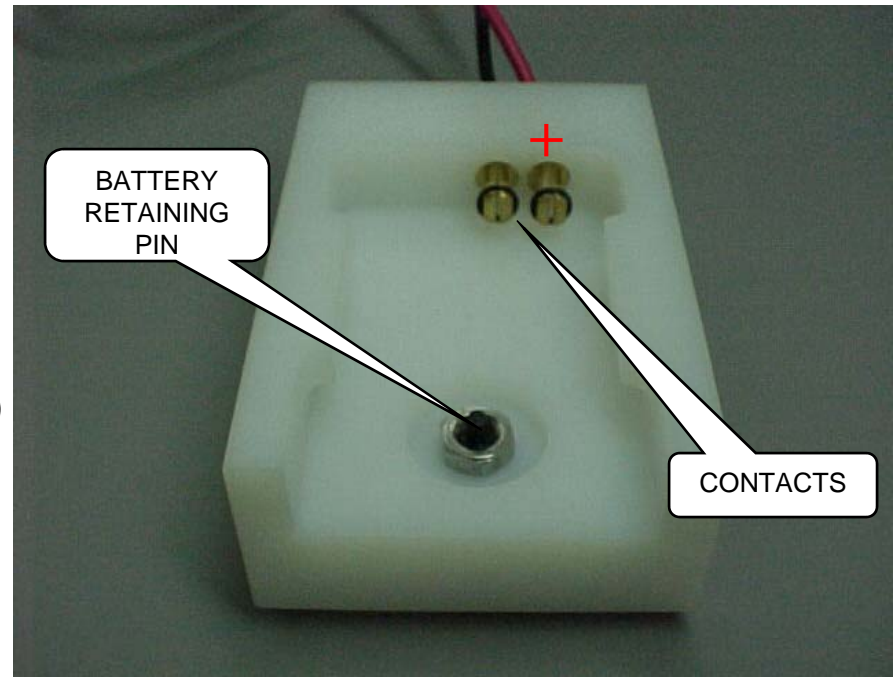

# REGULAR MAINTENANCE

- BATTERY CHARGING IS THE MOST IMPORTANT PART OF EVP PERFORMANCE AND MAINTENANCE. FOLLOW THE MANUFACTURERS INSTRUCTIONS FOR CHARGING THE BATTERY. A FULLY CHARGED BATTERY WILL RUN THE PUMP FOR 3 MINUTES
- THE BATTERY MOUNTING BLOCK CONTACTS WILL NEED TO BE CHECKED FOR GAP (.017"). THE O-RING WILL MAINTAIN THE GAP, HOWEVER IF A BATTERY TERMINAL IS BENT, IT WILL SPRING THE CONTACT OPEN OR MAY FOLD IT OVER. IF THE BATTERY DOES NOT "SLIDE" INTO PLACE THE GAP IS TOO SMALL OR THE BATTERY TERMINAL(S) MAY BE BENT. THE GAP IS EASILY OPENED WITH A SCREW DRIVER OR CLOSED WITH PLIERS.

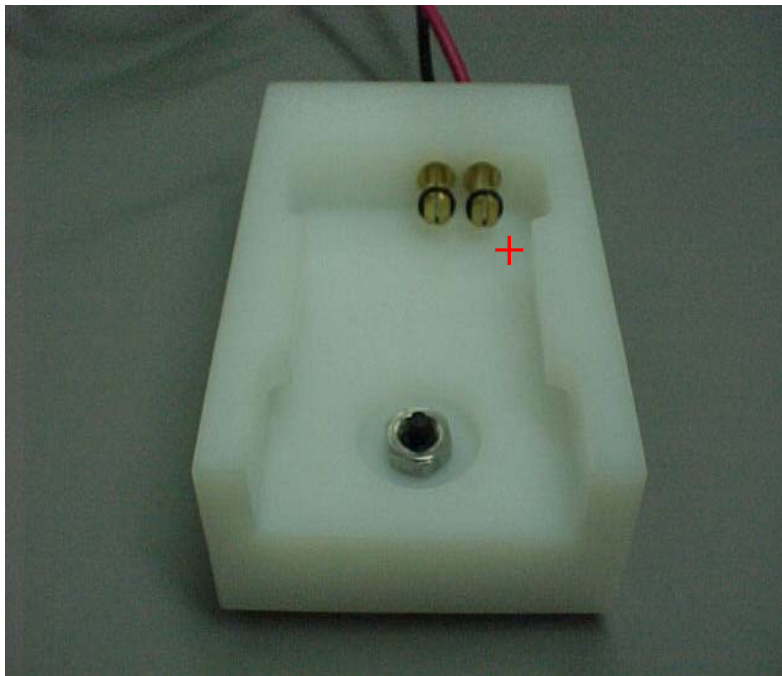

## BATTERY PERFORMANCE TIPS:

### NICAD:

1. CHARGE BATTERY IMMEDIATELY AFTER USE
2. FULLY DISCHARGE BATTERY BEFORE CHARGING
3. CHARGE EVERY 3 MONTHS WHEN NOT IN USE
4. DO NOT STORE BATTERY ON CHARGER
5. DO NOT STORE OUTDOORS OR IN DAMP LOCATIONS

### NIMH:

1. MAX CAPACITY REACHED IN 5-6 CHARGE/DISCHARGE CYCLES
2. CHARGE EVERY 3 MONTHS WHEN NOT IN USE
3. DO NOT STORE BATTERY ON CHARGER
4. DO NOT STORE OUTDOORS OR IN DAMP LOCATION

# DYNAMIC SEAL REPLACEMENT

## THE RUBBER QUATRO RING SEAL IS OBSOLETE THE REPLACEMENT IS UHMW, PN STR.18.02.124

- REPLACE ONE SEAL AT A TIME (REMOVE ONE HEAD ONLY)
- REMOVE THE THREE #10-24 SHCS (5/32" ALLEN) MOUNTING THE HEAD (PG. 11, PHOTO 1)  
ROTATE THE PUMP GEAR TO POSITION THE YOKE (PIN) IN THE CENTER OF STROKE (PG. 11, PHOTO 2)
- REMOVE THE PISTON ¼-20 SHFH (5/32" ALLEN) , PUSH ON ONE SIDE OF THE PISTON, ROTATING IT 90 DEGS.  
PULL THE PISTON OUT (PG. 11, PHOTO 4)
- REMOVE THE SEAL AND CLEAN THE PISTON GROOVE.
- PLACE WITH THE NEW UHMW SEAL ON PISTON.(PG. 12, PHOTOS 7 & 8.
- PLACE PISTON INTO BORE (PG. 12, PHOTO 9)
- PUSH ON EDGE TO ROTATE PISTON SQUARE IN BORE (PG. 12, PHOTO 10)
- USE 5/32" ALLEN WRENCH TO ALIGN BOLT HOLE IN PISTON TO TAPPED HOLE IN YOKE (PG. 12, PHOTO 11)  
INSTALL SCREW (DO NOT TIGHTEN)
- ROTATE GEAR TO PUT THE PISTON (PIN) TO END OF STROKE (PG. 11, PHOTO 2)
- BEFORE TIGHTENING THE SCREW, BE SURE THAT THE PISTON HUB (PG. 11 PHOTO 6) IS SEATED INTO  
THE YOKE COUNTER BORE (PG. 11 PHOTO 5) THIS IS EVIDENT (PG. 11 PHOTO 3) WHEN THE PISTON IS  
AT END OF IT'S STROKE, SQUARE TO THE CYLINDER AND .030" DOWN FROM THE CYLINDER LIP.
- LUBRICATE THE HEAD O-RING AND THE TUBE BORES WITH ENGINE OIL. (PG. 13 PHOTO 13)
- REPLACE THE HEAD (PG. 13. PHOTOS 14 & 15)
- REPEAT THE STEPS ABOVE TO REPLACE THE OTHER SEAL

# DYNAMIC SEAL REPLACEMENT

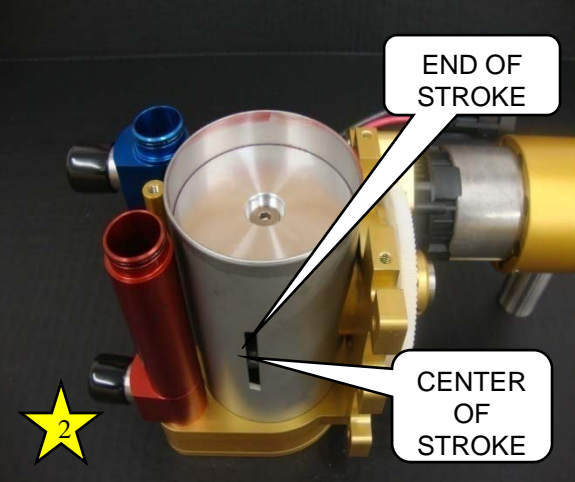
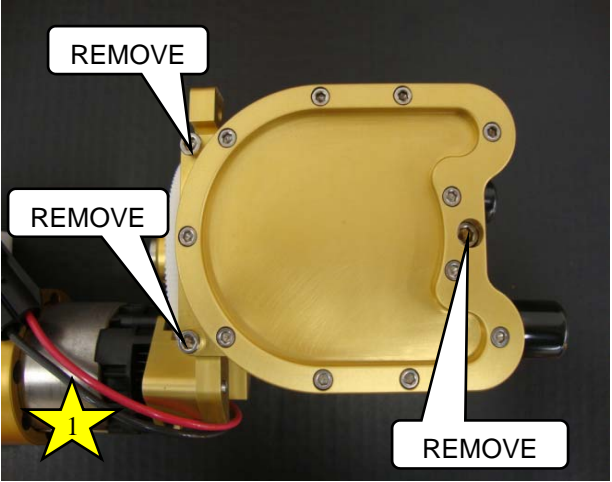



# DYNAMIC SEAL REPLACEMENT

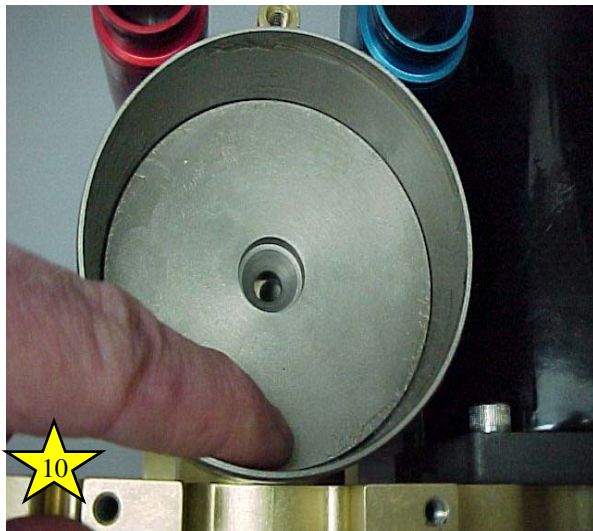



# DYNAMIC SEAL REPLACEMENT

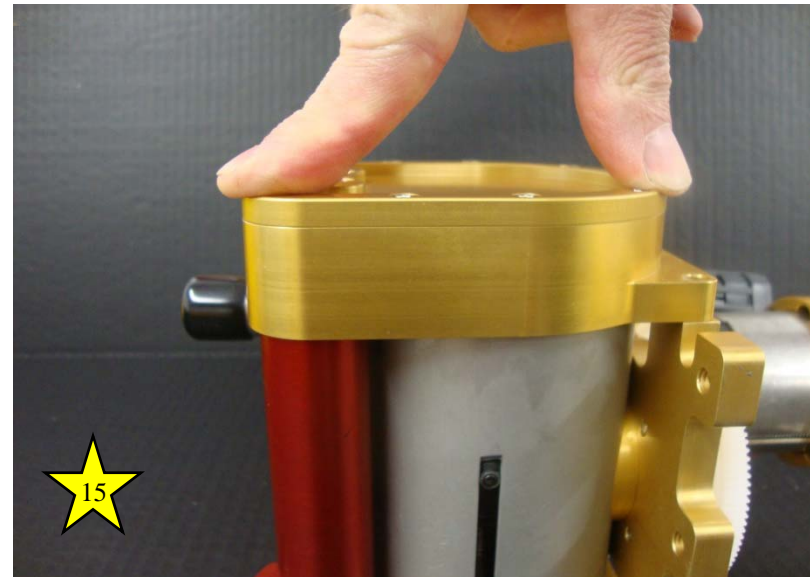
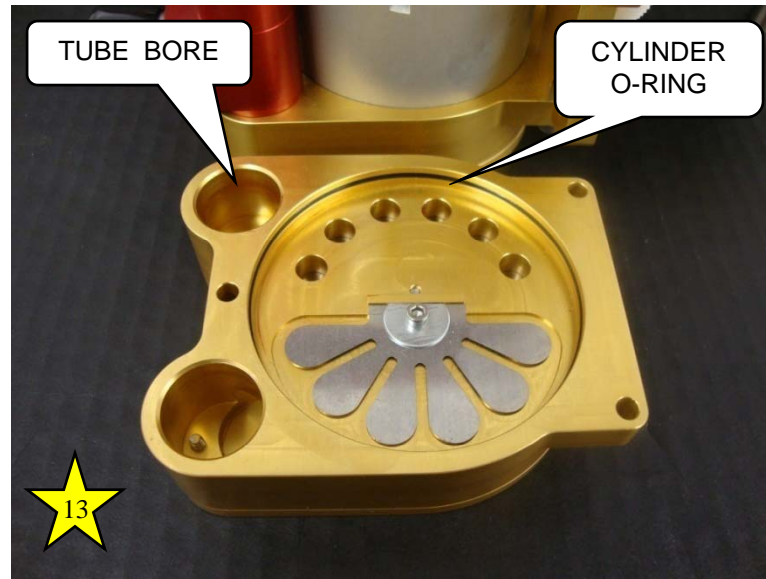

## INTAKE/EXHAUST TUBE REPOSITIONING

- FOLLOW THE INSTRUCTIONS ON PG. 11, PHOTO 1
- MOVE THE TUBES, ALWAYS KEEP THE BLUE TUBE HIGH AS THE MOTOR  
LUBE THE O-RINGS. REINSTALL THE HEAD

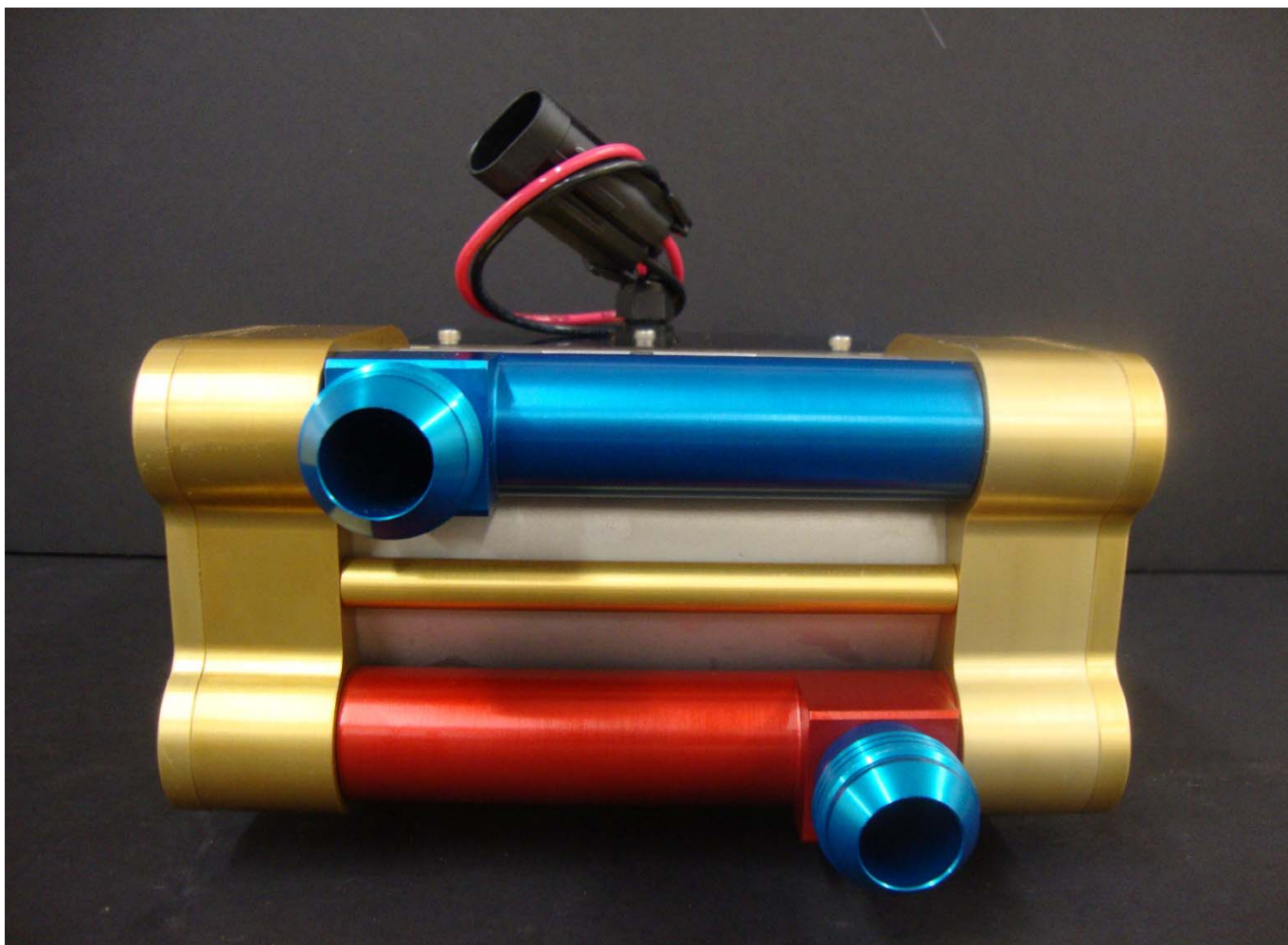

## TWIN MOTOR WIRING

**NOTE: THE TWIN MOTORS ARE POLARITY SENSITIVE !**

**ALWAYS MAINTAIN POSITIVE TO POSITIVE AND NEGATIVE TO NEGATIVE BETWEEN MOTORS, CONNECTORS AND TO THE BATTERY**

